



# **User Manual**

RESmart GII Auto CPAP System

E-20A-H-O / E-20AJ-H-O



# Table of Contents

1. Symbols .....	1
1.1 Control Buttons .....	1
1.2 Device Symbols .....	1
2. Warning, Caution and Important Tip .....	2
3. Intended Use .....	2
4. Contraindications .....	3
5. Specifications .....	4
6. Available Therapies .....	5
7. Glossary .....	6
8. Model .....	7
9. Package Contents .....	7
10. System Features .....	8
11. First Time Setup .....	9
11.1 Placing the Device .....	9
11.2 Installing the Air Filter and Filter Cap .....	10
11.3 Connecting to Power .....	10
11.4 Assembling the Tube and Mask .....	11
11.5 Using Oxygen with the Device .....	12
11.6 Inserting the SD Card .....	12
11.7 Using the SpO <sub>2</sub> Kit .....	13
11.7.1 Connecting the SpO <sub>2</sub> Kit to the Main Device .....	13
11.7.2 Removing the SpO <sub>2</sub> Kit from the Main Device .....	14
11.8 Using the H60 Heated Humidifier .....	16
11.9 Starting Treatment .....	16
12. Routine Use .....	16
12.1 Connecting the Tube .....	16
12.2 Adjusting the Tube .....	16
12.3 Turning on the Airflow .....	16
12.4 Heating the Water in the Humidifier .....	17
12.5 Using the Ramp Button .....	17
12.6 Turning the Device Off .....	17
13. Navigating the Patient Menu .....	18
13.1 Steps to Navigating the Patient Menu .....	18
13.1.1 Accessing the Main Interface .....	18
13.1.2 Bringing up the Initial Setup Interface .....	18
13.1.3 Accessing the Setup Interface .....	18
13.1.4 Selecting Options .....	19
13.1.5 Adjusting Options .....	19
13.1.6 Confirming Adjustments .....	19
13.1.7 Turning Pages .....	20
13.1.8 Exiting the Patient Menu .....	20
13.2 Options of the Patient Menu and Corresponding Descriptions .....	21
14. Alert .....	22
15. Cleaning and Disinfection .....	23
15.1 Cleaning the Mask and Headgear .....	23
15.2 Cleaning the SpO <sub>2</sub> Kit .....	23
15.3 Cleaning the Water Chamber of the Humidifier .....	23
15.4 Cleaning the Enclosure .....	23
15.5 Cleaning the Tube .....	23
15.6 Replacing the Air Filter .....	24
15.7 Disinfection .....	24
16. Traveling with the Device .....	25

















17. Transferring the Device to Another Patient	26
18. Reordering	26
19. Technical Support	26
20. Disposal	26
21. Troubleshooting	27
21.1 Common Problems in Patients and Corresponding Solutions	27
21.2 Common Problems in the Device and Corresponding Solutions	29
22. EMC Requirements	30
23. Limited Warranty	34

# 1. Symbols

## 1.1 Control Buttons

-  Ramp Button
-  Mute Button
-  Knob

## 1.2 Device Symbols

-  Follow Instructions for Use
-  Operating Instructions
-  Type BF Applied Part
-  Class II (Double Insulated)
-  AC Power
-  DC Power
- IP22** ≥12.5 mm Diameter, Dripping (15° tilted)
-  Hot Surface
-  No SpO<sub>2</sub> Alarm
-  Serial Number of the Product
-  Manufacturer
-  Authorized Representative in the European Community
-  European CE Declaration of Conformity
-  SD Card
-  Water Filling Prohibited Here
-  Water Inlet
-  Directional Indicator for Removing the Water Inlet Cap
-  Directional Indicator for Screwing the Water Inlet Cap

## ***2. Warning, Caution and Important Tip***

### ***WARNING!***

Indicate the possibility of injury to the user or operator.

### ***CAUTION!***

Indicate the possibility of damage to the device.

### ***IMPORTANT TIP!***

Place emphasis on an operating characteristic.

Warnings, Cautions, and Important Tips appear throughout this manual as they apply.

## ***3. Intended Use***

The E-20A system is a CPAP (Continuous Positive Airway Pressure) device designed for the treatment of adult Obstructive Sleep Apnea (OSA) only.

The device is to be used only on the instruction of a licensed health care professional. Your home care provider will make the correct pressure settings according to your health care professional's prescription.

Several accessories are available to make your OSA treatment with this device as convenient and comfortable as possible. To ensure that you receive the safe, effective therapy prescribed for you, use only BMC accessories.

### ***WARNINGS!***

- This device is intended for adult use only.
- This device is not intended for life support.
- The instructions in this manual are not intended to supersede established medical protocols.

### ***CAUTION!***

- This device is restricted to sale by or on the order of a physician.

### ***IMPORTANT!***

- Read and understand the entire user manual before operating this system. If you have any questions concerning the use of this system, contact your home care provider or health care professional.

## ***4. Contraindications***

Studies have shown that the following pre-existing conditions may contraindicate the use of positive airway pressure therapy for some patients:

**Absolute Contraindications:** Pneumothorax, mediastinal emphysema; cerebrospinal fluid leak, traumatic brain injury, or pneumocephalus; shock caused by a variety of conditions before treatment; active epistaxis; upper gastrointestinal bleeding before treatment; coma or impaired consciousness making the use of mask during therapy impossible; giant vocal fold polyp, etc.

**Relative Contraindications:** Severe coronary heart disease complicated with left ventricular failure, acute otitis media, excessive respiratory secretions and weak cough, weak spontaneous breathing, nasal or oral tracheal intubation and tracheotomy, severe nasal congestion caused by a variety of conditions, lung bullae, and allergies to breathing masks, etc.

The following side effects may occur during treatment:

- Dryness of the mouth, nose and throat
- Abdominal bloating
- Ear or sinus discomfort
- Eye irritation
- Skin irritation due to the use of a mask
- Chest discomfort

### ***IMPORTANT!***

- An irregular sleep schedule, alcohol consumption, obesity, sleeping pills, or sedatives may aggravate your symptoms.

### ***CAUTION!***

- Contact your health care professional if symptoms of sleep apnea recur. Contact your health care professional if you have any questions concerning your therapy.

## 5. Specifications

### **Device Size**

Dimensions: 170 mm × 196 mm × 118 mm, or 290 mm × 196 mm × 134 mm (with the humidifier)

Weight: 1.5 kg, or 2.5 kg (with the humidifier)

### **Product Use, Transport and Storage**

Operation	Transport and Storage
Temperature: 5°C to 35°C (41°F to 95°F)	-25°C to 70°C (-13°F to 158°F)
Humidity: 15% to 93% Non-condensing	15% to 93% Non-condensing
Atmospheric Pressure: 760 ~ 1060 hPa	760 ~ 1060 hPa

### **Mode of Operation**

Continuous

### **Work Mode**

CPAP, Auto

### **SD Card**

With a capacity  $\geq 2$  G, the SD card can record patient data and fault information. Furthermore, the language pack stored on the SD card enables you to change the language of the device.

### **AC Power Consumption**

100 ~ 240 V AC, 50 / 60 Hz, 2.0 A max

### **Type of Protection Against Electric Shock**

Class II Equipment

### **Degree of Protection Against Electric Shock**

Type BF Applied Part

### **Degree of Protection Against Ingress of Water**

IP22

### **Pressure Range**

4 to 20 hPa (in 0.5 hPa increments),  $\leq 30$  hPa under single fault conditions.

### **Pressure Display Accuracy**

$\pm(0.5 \text{ hPa} + 4\%)$

### **Pressure Stability**

4 to 20 hPa ( $\pm 1$  hPa)

### **Ramp**

The ramp time ranges from 0 to 60 minutes.

### **Sound Pressure Level**

$< 30$  dB, when the device is working at the pressure of 10 hPa.

**Sound Power Level**

<38 dB, when the device is working at the pressure of 10 hPa.

**Maximum Flow**

Test Pressure (hPa)	4	9	15	20
Average Flow at the Patient Connection Port (l/min)	80	92	91	96

**SpO<sub>2</sub>**

Range: 0 ~ 100%

The margin of error for SpO<sub>2</sub> between 70% and 100% is ±3%. No strict accuracy requirements for SpO<sub>2</sub> below 70%.

**Pulse Rate**

Range: 40 ~ 240 BPM

Margin of Error: ±3%

**Wavelengths**

Red: 663 nanometers

Infrared: 890 nanometers

**Maximal Optical Output Power**

Less than 1.5 mw maximum average.

**Tube**

Length: 6 ft. (1.83 m)

**The Form and the Dimensions of the Patient Connection Port**

The 22 mm conical air outlet complies with ISO 5356-1.

## 6. Available Therapies

The device delivers the following therapies:

**CPAP** – Delivers Continuous Positive Airway Pressure; CPAP maintains a constant level of pressure throughout the breathing cycle. If your health care professional has prescribed ramp for you, you can press **the Ramp Button**  to reduce the pressure and then gradually increase the pressure to the therapeutic pressure setting so that you can fall asleep more comfortably.

**Auto** – Delivers CPAP therapy and provides an air pressure no less than the prescribed one based on the patient's needs.



## **7. Glossary**

### ***Apnea***

A condition marked by the cessation of spontaneous breathing.

### ***Auto-CPAP***

Adjust CPAP pressure automatically to improve patient comfort based on monitoring of apnea and snoring events.

### ***Auto Off***

When this feature is enabled, the device automatically discontinues therapy whenever the mask is removed.

### ***Auto On***

With this feature, the device automatically initiates therapy when you breathe into the mask. This feature is always enabled.

### ***CPAP***

Continuous Positive Airway Pressure.

### ***iCode***

A feature that is intended to give access to compliance and therapy management information. The "iCode" consists of six separate codes displayed in the Patient Menu. iCode I displays sequences of characters, and iCode II displays two-dimensional codes .

### ***LPM***

Liters Per Minute.

### ***OSA***

Obstructive Sleep Apnea.

### ***Patient Menu***

The display mode in which you can change patient-adjustable device settings, such as the starting pressure for the Ramp feature.

### ***Ramp***

A feature that may increase patient comfort when therapy is started. It can reduce pressure and then gradually increase the pressure to the prescription setting so the patient can fall asleep more comfortably.

### ***Reslex***

A therapy feature that is enabled by your home care provider to provide pressure relief during exhalation.

### ***Standby State***

The state of the device when power is applied but the airflow is turned off.

## 8. Model

Model	Product Description				Maximum Work Pressure (hPa)
	Product Contents	Optional Accessory 1	Optional Accessory 2	Work Mode	
E-20A-H-O	Main device (3.5-inch LCD)	Heated Humidifier	SpO <sub>2</sub> Kit	CPAP, Auto	20
E-20AJ-H-O	Main device (2.4-inch LCD)				

## 9. Package Contents

After unpacking the system, make sure you have everything shown here:

No.	Articles	Qty.	Notes
1	Main Device	1	
2	Heated Humidifier	1	Optional
3	Shield	1	
4	Air Filter	2	
5	Power Adapter	1	
6	Power Cord	1	
7	SpO <sub>2</sub> Kit	1	Optional
8	SD Card	1	
9	Carrying Case	1	
10	User Manual	1	
11	Quick Operation Manual	1	

All parts and accessories do not contain latex.

### **IMPORTANT!**

- If any of the above parts are missing, contact your home care provider.
- Contact your home care provider for additional information on the available accessories of this device. When using optional accessories, always follow the instructions enclosed with the accessories.

### **WARNINGS!**

- This device should only be used with the mask and accessories manufactured or recommended by BMC or with those recommended by your prescribing physician. The use of inappropriate masks and accessories may affect the performance of the device and impair the effectiveness of therapy.
- The use of accessories other than those specified, with the exception of cables sold by the manufacturer of the equipment or system as replacement parts for internal components, may result in increased emissions or decreased immunity of the equipment or system.

## 10. System Features

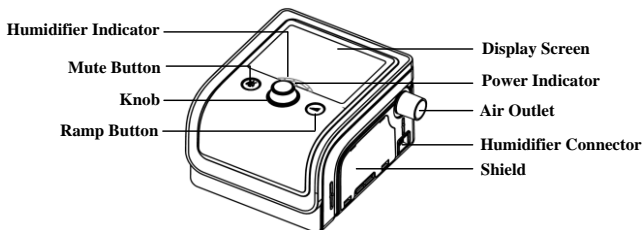

Fig. 10-1

Name	Function
Humidifier Indicator	Indicate the humidity level. There are five levels in total. The number of indicator lights that light up is directly proportional to the humidity level. If none of the indicator lights light up, it means the humidifier is turned off
Mute Button	Press this button to mute the alert. However, if the problem causing the alert is not solved, the alert will sound again two minutes later
Knob	Start treatment and adjust device settings
Ramp Button	Enable the Ramp feature
Display Screen	Display menus for operation, messages, monitoring data, etc.
Power Indicator	Indicate the power supply status
Air Outlet	Deliver pressurized air; connected to the tube or the air inlet of the humidifier
Humidifier Connector	Provide power to the humidifier which is connected to the main device
Shield	Connect the humidifier to the main device after this shield is removed

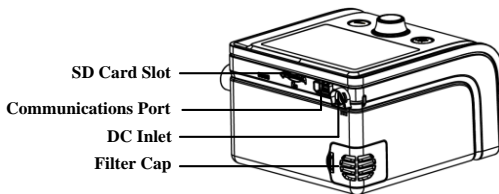

Fig. 10-2

Name	Function
SD Card Slot	Insert the SD card into this slot
Communications Port	Connected to external equipment
DC Inlet	An inlet for the DC power supply
Filter Cap	Place the cap on the air filter, which is used to filter dust and pollen in the air entering the device

## 11. First Time Setup

### 11.1 Placing the Device

Place the device on a firm, flat surface.

#### **WARNINGS!**

- If the device has been dropped or mishandled, if the enclosure is broken, or if water has entered the enclosure, disconnect the power cord and discontinue use. Contact your home care provider immediately.
- If the room temperature is warmer than 95°F (35°C), the airflow produced by the device may exceed 109.4°F (43°C). The room temperature must be kept below 95°F (35°C) while the patient uses the device.

#### **CAUTIONS!**

- If the device has been exposed to either very hot or very cold temperatures, allow it to adjust to room temperature (approximately 2 hours) before beginning setup.
- Make sure the device is away from any heating or cooling equipment (e.g., forced air vents, radiators, air conditioners).
- The device is not suitable for use in high humidity environments. Make sure that no water enters the device.
- Make sure that bedding, curtains, or other items are not blocking the filter or vents of the device.
- To avoid explosion, this device must not be used in the presence of flammable gases (e.g. anesthetics).
- Tobacco smoke may cause tar build-up within the device, leading to the malfunctioning of

the device.

- Air must flow freely around the device for it to work properly.

## 11.2 Installing the Air Filter and Filter Cap

- (1) Attach the air filter to the filter cap, as shown in Fig. 11-1.

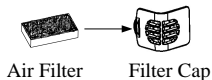

Fig. 11-1

- (2) Install the filter cap containing the air filter to the main device, as shown in Fig. 11-2.

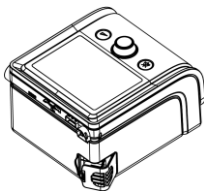

Fig. 11-2

### **CAUTION!**

- The air filter must be in place when the device is operating.

## 11.3 Connecting to Power

- (1) Insert the plug of the power adapter into the DC Inlet on the back of the device;
- (2) Connect the power cord to the power adapter;
- (3) Plug the other end of the power cord into the power outlet.

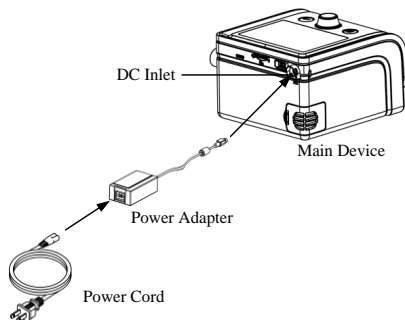



Fig. 11-3

### **WARNINGS!**

- The device is powered on for use when the power cord and power adapter is connected. The **Knob**  turns the blower On / Off.

- Use of the device at an AC voltage beyond the stated range (see Section 5 “AC Power Consumption”) may damage the device or cause device failure.

**CAUTION!**

- Inspect the power cord often for any signs of damage. Replace a damaged cord immediately.

**IMPORTANT!**

- After interruption and restoration of the power supply, the device will restore its pre-interruption working status automatically.
- To remove AC power, disconnect the power cord from the power outlet.

## 11.4 Assembling the Tube and Mask

(1) Connect one end of the tube to the air outlet of the main device, as shown in Fig. 11-4. If the main device is used with a humidifier, connect one end of the tube to the air outlet of the humidifier, as shown in Fig. 11-5.

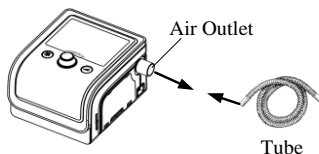

Fig. 11-4

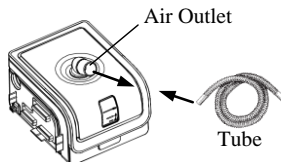

Fig. 11-5

(2) Connect the other end of the tube to the mask according to the user manual for the mask. Wear the mask.

**WARNINGS!**

- If multiple persons are going to use the device (e.g., rental devices), a low-resistance, main flow bacteria filter should be installed in-line between the device and tube. Pressures must be verified by your home care provider when alternate or optional accessories are in place.
- If you are using a mask with a built-in exhalation port, connect the mask's connector to the tube.
- If you are using a mask with a separate exhalation port, connect the tube to the exhalation port. Position the exhalation port so that the vented air is blowing away from your face. Connect the mask's connector to the exhalation port.

- If you are using a full-face mask (a mask covering both your mouth and nose), the mask must be equipped with a safety (entrainment) valve.
- In order to minimize the risk of CO<sub>2</sub> rebreathing, the patient should observe the following instructions:
  - Use the accompanying tube and mask provided by BMC.
  - Do not wear the mask for more than a few minutes while the device is not operating.
  - Use only masks with vent holes. Do not block or try to seal the vent holes in the exhalation port.

## 11.5 Using Oxygen with the Device

Oxygen may be added at the mask connection. Please observe the instructions listed below when using oxygen with the device.

### **WARNINGS!**

- Connect the oxygen tube to the oxygen inlet of the mask.
- The oxygen supply must comply with the local regulations for medical oxygen.
- Turn on the device before turning on the oxygen. Turn off the oxygen before turning off the device. Explanation of Warning: When the device is turned off, but the oxygen flow still exists, oxygen may accumulate within the device's enclosure and pose a fire hazard. Turning off the oxygen before turning off the device will prevent oxygen accumulation in the device and reduce the risk of fire. This warning applies to most CPAP devices.
- Oxygen supports combustion. Keep the device and the oxygen container away from heat, open flames, any oily substances, or other sources of ignition. DO NOT smoke in the area near E-20A or the oxygen container.
- Sources of oxygen should be located more than 1 m from the device.

## 11.6 Inserting the SD Card

Insert the SD card into the SD Card Slot, as shown in Fig. 11-6.

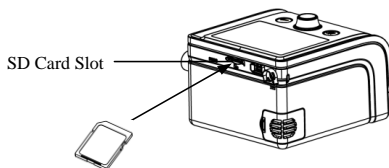

Fig. 11-6

If the SD card is inserted correctly, a symbol indicating correct insertion will appear in the Main Interface on the screen of the device, as shown in Fig. 11-7.

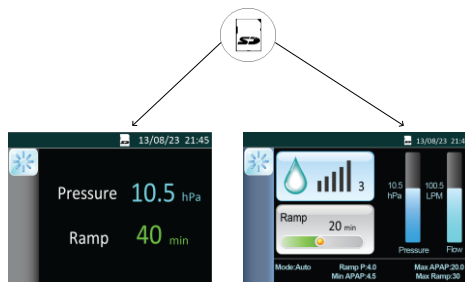

Fig. 11-7

If the SD card is inserted incorrectly or not inserted, a symbol indicating incorrect insertion or no SD card present will appear in the Main Interface on the screen of the device, as shown in Fig. 11-8.

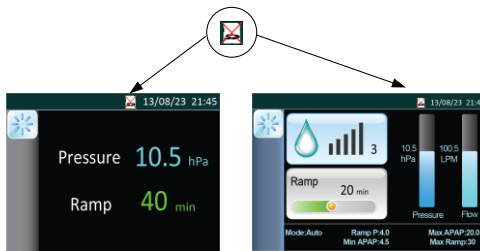

Fig. 11-8

### **CAUTION!**

- To avoid data loss or any damage to the SD card, the SD card can only be removed after the main device stops delivering air.

## **11.7 Using the SpO<sub>2</sub> Kit**

The SpO<sub>2</sub> Kit consists of a **SpO<sub>2</sub> Probe**, **Adapter**, and **Connector**, as shown in Fig. 11-9.

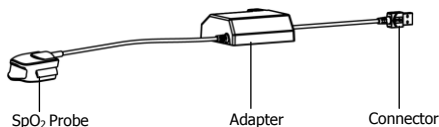

Fig. 11-9

### **11.7.1 Connecting the SpO<sub>2</sub> Kit to the Main Device**

(1) Pull the **Adhesive-backed Paper** off the **Base Plate** as indicated by the arrow icon in the top left of Fig. 11-10.



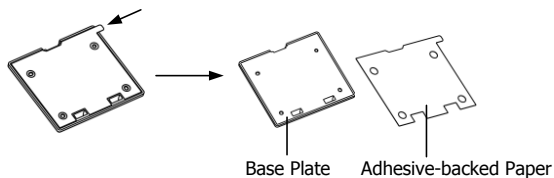

Fig. 11-10

(2) Point the four holes of the **Base Plate** towards the four reference points on the back of the main device to properly stick the plate to the device, as shown in Fig. 11-11.

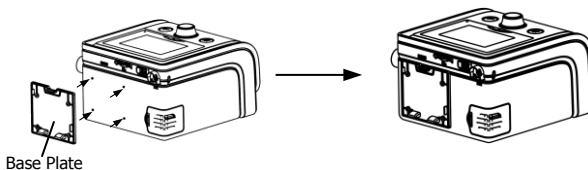

Fig. 11-11

(3) Point the two **Buckles** at the back of the SpO<sub>2</sub> Kit adapter towards the two buckles of the base plate, and push until the two units click into place. Insert the SpO<sub>2</sub> Kit connector into the **Communications Port** of the main device, as shown in Fig. 11-12.

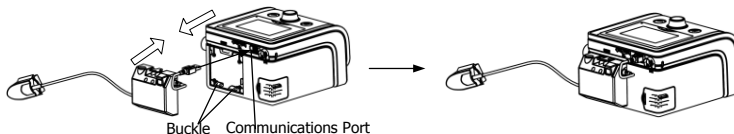

Fig. 11-12

### 11.7.2 Removing the SpO<sub>2</sub> Kit from the Main Device

First disconnect the SpO<sub>2</sub> Kit connector from the **Communications Port**; then press the **Hook** at the top of the SpO<sub>2</sub> Kit adapter, and at the same time, pull the adapter and base plate apart in opposite horizontal directions, as shown in Fig. 11-13.

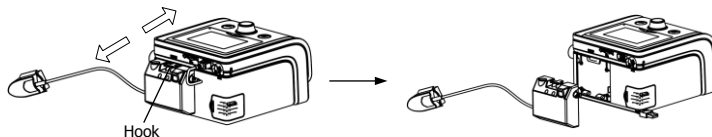

Fig. 11-13

The SpO<sub>2</sub> Kit is intended to be used for continuous, non-invasive functional arterial oxygen saturation (SpO<sub>2</sub>) and pulse rate monitoring for adults weighting greater than 40 kg. The SpO<sub>2</sub> Kit is ready to use immediately when you connect it to the main device via the

Communications Port.

The model of the SpO<sub>2</sub> Kit is KS-CM01. The SpO<sub>2</sub> Kit is calibrated to display FUNCTIONAL OXYGEN SATURATION.

Attach its sensor to the patient's index finger or any other finger.

The sampling rate of the SpO<sub>2</sub> signal is about 50 Hz, and the update rate of the frame is 1 Hz.

The value of SpO<sub>2</sub> and PR is calculated by the average of the former eight pulse waveforms.

If the SpO<sub>2</sub> Kit is in an abnormal state, the value of SpO<sub>2</sub> will be blank.

The screen of the main device then displays the Main Interface shown in Fig. 11-14 (only applies to E-20A-H-O), or the Main Interface shown in Fig. 11-15 (only applies to E-20AJ-H-O). The patient's blood oxygen saturation and pulse rate can be clearly seen during the course of therapy.



Fig. 11-14

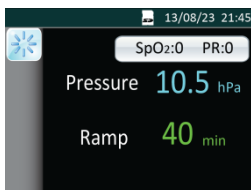

Fig. 11-15

### ***WARNINGS!***

- Change the measurement point regularly according to the patient's conditions after prolonged use. Change the measurement point, check the patient's skin integrity and circulatory conditions, and make the right adjustments at least every eight hours.
- Excessive ambient light, excessive motion, use of intravascular dyes, poorly perfused finger, extreme finger sizes or improper placement may degrade the SpO<sub>2</sub> Kit's performance or affect the accuracy of the measurement.
- Nail polish or false nails should be removed before the finger sensor is used, or it may cause erroneous measurements results.
- Overly low blood pressure, overly low systolic blood pressure, severe anemia, or hypothermia may cause erroneous measurements results.
- The SpO<sub>2</sub> Kit is designed for use with this device only.
- Verify the compatibility of the device and SpO<sub>2</sub> Kit before use, otherwise it may cause injury to the patient.
- Misapplication of a SpO<sub>2</sub> Kit with excessive pressure for prolonged periods can induce

pressure injury.

- A FUNCTIONAL TESTER cannot be used to assess the ACCURACY of the SpO<sub>2</sub> Kit.
- Do not use the SpO<sub>2</sub> Kit during MRI scanning.
- Do not use the SpO<sub>2</sub> Kit if it appears damaged.
- Do not immerse the SpO<sub>2</sub> Kit as it causes short.

## ***11.8 Using the H60 Heated Humidifier***

The H60 Heated Humidifier is available from your home care provider. The humidifier may reduce nasal dryness and irritation by adding moisture (and heat if applicable) to the airflow. For detailed information about the heated humidifier, please see the user manual for the heated humidifier.

## ***11.9 Starting Treatment***

Connect the device to a power outlet, press **the Knob** , and the device will start delivering air.

### ***WARNINGS!***

- Be sure to follow your physician's instructions on adjusting the settings! To order any accessories not included with this device, contact your equipment supplier.
- DO NOT connect any ancillary equipment to this device unless recommended by BMC or your physician. If you suffer from chest discomfort, shortness of breath, stomach bloating, or severe headache when using the device, contract your physician or qualified medical personnel immediately.

## ***12. Routine Use***

### ***12.1 Connecting the Tube***

Connect the power cord, power adapter, and tube properly according to the instructions in the First Time Setup (Chapter 11). Connect the mask and headgear according to the user manual for the mask.

### ***CAUTION!***

- Before each use, examine the tube for any damage or debris. If necessary, clean the tube to remove the debris. Replace any damaged tube. Make sure that the mask does not leak.

### ***12.2 Adjusting the Tube***

Lie down on your bed, and adjust the tube so it is free to move if you turn during sleep. Adjust the mask and headgear until you have a comfortable fit and until there are no airflow leaks into your eyes.

### ***12.3 Turning on the Airflow***

Press **the Knob**  to turn on the airflow. The screen will display treatment pressure and other information.

## ***12.4 Heating the Water in the Humidifier***

Pay attention to the humidifier indicator lights when using the device with a humidifier. The indicator lights indicate the On / Off state of the humidifier. It is off when all indicator lights go out.

### ***CAUTION!***

- Observe the water level of the water chamber before using the humidifier. Make sure there is sufficient water in the water chamber, and avoid heating the humidifier with an empty water chamber.

## ***12.5 Using the Ramp Button***

Every time **the Ramp Button**  is pressed, the pressure will drop to the initial pressure, and then gradually rise to the prescribed treatment pressure according to the preset ramp time, so as to make the patient fall asleep easily. The screen displays a real-time countdown of the remaining ramp time in minutes.

### ***CAUTIONS!***

- You can press **the Ramp Button**  as often as you wish during sleep.
- The ramp feature is not prescribed for all users.

## ***12.6 Turning the Device Off***

Take off the mask and headgear, press and hold **the Knob**  for two seconds, and the device will stop delivering air. Disconnect the power cord from the power outlet to power off the device.

## 13. Navigating the Patient Menu

### 13.1 Steps to Navigating the Patient Menu

#### 13.1.1 Accessing the Main Interface

Connect the power cord and power adapter properly. The screen displays the Main Interface shown in Fig. 13-1 (only applies to E-20A-H-O), or the Main Interface shown in Fig. 13-2 (only applies to E-20AJ-H-O).

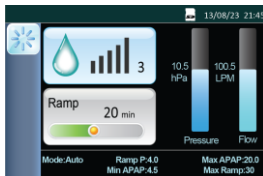

Fig. 13-1

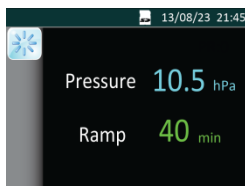



Fig. 13-2

#### 13.1.2 Bringing up the Initial Setup Interface

From the Main Interface shown in Fig. 13-1 or Fig. 13-2, or when the device delivers air, press and hold **the Ramp Button**  for three seconds. The screen displays the Initial Setup Interface of the Patient Menu, as shown in Fig. 13-3.

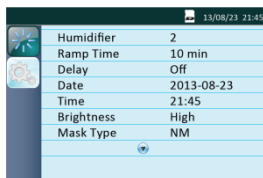







Fig. 13-3

The first icon  on the left side of the screen indicates the Main Interface, and the second icon  indicates the Initial Setup Interface. As you turn **the Knob** , the cursor switches between the two icons, and the interface displayed on the screen changes accordingly.

#### 13.1.3 Accessing the Setup Interface

When the cursor is on the icon , the screen displays the Setup Interface. Access the Setup Interface by pressing **the Knob** . The first option on the Setup Interface is then displayed in blue, as shown in Fig. 13-4.

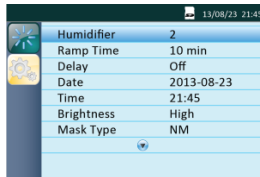

Fig. 13-4

### 13.1.4 Selecting Options

As you turn **the Knob** ⌚ clockwise, the cursor moves downwards from one option to another. As you turn it counterclockwise, the cursor moves upwards. When the cursor is on a certain option, press **the Knob** ⌚, and the option is then displayed in yellow, meaning that the option can now be adjusted, as shown by the **Humidifier** option in Fig. 13-5.

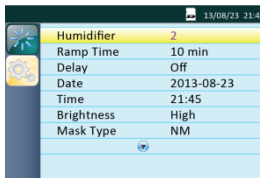

Fig. 13-5

### 13.1.5 Adjusting Options

Adjust the option by turning **the Knob** ⌚. As shown in Fig. 13-5, the **Humidifier** option is selected. As you turn **the Knob** ⌚ clockwise, the numbering increases, indicating a higher humidity level. As you turn **the Knob** ⌚ counterclockwise, the numbering decreases, indicating a lower humidity level. At this moment, the **Humidifier** option is still displayed in yellow, as shown in Fig. 13-6.

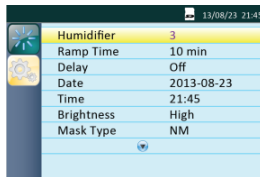

Fig. 13-6

### 13.1.6 Confirming Adjustments

Confirm your adjustment to an option by pressing **the Knob** ⌚. The option is then displayed in blue, as shown in Fig. 13-7.

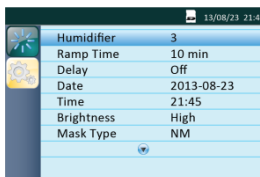

Fig. 13-7

### 13.1.7 Turning Pages

When the cursor is on **Mask Type**, the last option shown in Fig. 13-7, the remaining options will appear on a new page if you continue to turn **the Knob** ⌚ clockwise, as shown in Fig. 13-8.

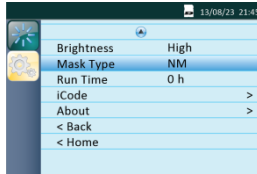

Fig. 13-8

Note: ⌚ are page turning symbols.

### 13.1.8 Exiting the Patient Menu

(1) Returning to the Initial Setup Interface

Move the cursor to the **Back** option by turning **the Knob** ⌚, as shown in Fig. 13-9.



Fig. 13-9

Press **the Knob** ⌚, the cursor jumps to the second icon ⚙️ on the left side of the screen. The screen displays the Initial Setup Interface, as shown in Fig. 13-10.

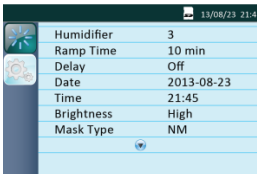

Fig. 13-10

(2) Returning to the Main Interface



Move the cursor to the **Home** option by turning **the Knob** ⌚, as shown in Fig. 13-11.



Fig. 13-11

Press **the Knob** ⌚ to exit the Patient Menu. The screen will display the Main Interface shown in Fig. 13-1 or Fig. 13-2.

## 13.2 Options of the Patient Menu and Corresponding Descriptions

Option	Range	Description
Humidifier	Off, 1 ~ 5	There are five humidity levels available. As the numbering increases, the humidity rises accordingly. "Off" means the humidifier is turned off. The default setting is "2"
Reslex	Off, 1 ~ 3	This feature enables the device to automatically reduce the treatment pressure when the patient exhales, so as to make the user more comfortable. The higher the numbering is, the more pressure the device reduces. "Off" means this feature is disabled. The default setting is "Off"
Ramp Time	0 - Max Ramp	In order to increase comfort and help the patient fall asleep easily, the pressure can increase gradually, when the Ramp feature is enabled. The ramp time during which the initial pressure rises to the prescribed treatment pressure can be adjusted. As you turn <b>the Knob</b>  to the nearest point, the numbering increases or decreases by five minutes. The default setting is "10 minutes." The screen displays a real-time countdown of the remaining ramp time in minutes
Delay	On / Off	When the humidifier is on, this feature allows the airflow to continue for about 15 minutes at a low pressure (about 2 hPa) after you press <b>the Knob</b>  to discontinue treatment. This will blow off the vapor left in the humidifier to avoid any damage to the device. When this feature is set to "Off," which means it is disabled, the airflow stops delivering air instantly after you press <b>the Knob</b>  . The default setting is "Off"
Date	2000-01-01 — 2099-12-31	Setting date by adjusting this option
Time	—	Setting time by adjusting this option
Brightness	High / Low	Setting screen brightness by adjusting this option. The default setting is "High"
Mask Type	FM; NM; PM; A, B, C	There are three mask types available, namely FM (full-face mask), NM (nasal mask), and PM (nasal pillow mask). The default mask type is "NM," but the patient can choose other suitable masks as well. When selecting masks other than the above three types of BMC masks, the patient can identify the masks as A, B, or C
Run Time	0 ~ 50000 h	Run Time displays how long has the device been used by the user. The run time can be erased
iCode	iCode I, iCode II	iCode provides access to the patient's compliance data during a recent time period. The iCode I mode displays data in sequences of characters, and the iCode II mode displays data in two-dimensional codes



## 14. Alert

Alert Message	Description
Power Failure!!!	An audible alert will sound if the device is accidentally disconnected from power when it is delivering air. Note: (1) The alert will not sound if power failure occurs when the device is in standby state. (2) No alert message on the screen during a power failure
Device Fault!!!	An audible alert will sound if no airflow comes out of the machine; the screen will display " <b>Device Fault!!!</b> "
Leak!!	When the airflow is on, an audible alert will sound if the air leak rate exceeds 150 l/min; the screen will display " <b>Leak!!</b> "
Low Input Voltage!!	If you use a battery rather than an external power adapter to power the device, an audible alert will sound when the battery is low; the screen will display " <b>Low Input Voltage!!</b> "
Humidifier Failure!!	when humidifier is applied, an audible alert will sound when the humidifier fails to work; the screen will display " <b>Humidifier Failure!!</b> "
Please Change Filter!	When the Filter Alert feature is enabled, an audible alert will sound if an air filter has been used for more than six months; the screen will display " <b>Please Change Filter!</b> "
SD Card Full!	The screen will display " <b>SD Card Full!</b> " if the SD card has reached its maximum capacity
Reinsert SD card!	The screen will display " <b>Reinsert SD card!</b> " if the SD card fails to work

## ***15. Cleaning and Disinfection***

### ***WARNINGS!***

- Regular cleaning of the device and its accessories is very important for the prevention of respiratory infections.
- To avoid electric shock, always unplug the device before cleaning.
- Use washing liquid that is nontoxic to humans and does not cause allergies in humans.
- Follow the manufacturer's instructions on cleaning the mask and tube and on determining the frequency of cleaning.
- Before cleaning, check whether the device has been disconnected from the power supply, whether the power cord has been unplugged, and whether the water chamber of the humidifier has cooled down. Make sure the Humidifier plate has cooled down to room temperature, so you do not get burned.

### ***CAUTIONS!***

- Overheating of the materials could lead to early fatigue of these materials.
- Do not use solutions containing chlorinated lime, chlorine, or aromatic to clean the device and its accessories. Liquid soap containing the humidifying agent or antimicrobials should not be used either. These solutions may harden cleaned materials or reduce their life.
- Do not clean or dry the device and its accessories when the temperature is higher than 80°C (176°F). High temperatures could reduce product life.
- Do not immerse the device in any fluids.

### ***15.1 Cleaning the Mask and Headgear***

For details, refer to the cleaning instructions in the user manual for the mask.

### ***15.2 Cleaning the SpO<sub>2</sub> Kit***

Wipe the surface of the SpO<sub>2</sub> Kit with a clean, soft, and slightly damp cloth.

### ***15.3 Cleaning the Water Chamber of the Humidifier***

For details, refer to the cleaning instructions in the user manual for the humidifier.

### ***15.4 Cleaning the Enclosure***

Wipe the surface of the device with a soft, slightly damp cloth.

### ***CAUTION!***

- The device can only be used after the enclosure is dry, so that no moisture enters the device.

### ***15.5 Cleaning the Tube***

- (1) Remove the tube from the device and mask before cleaning.
- (2) Clean the tube in warm water which contains washing liquid, and then rinse it in clean water thoroughly.

(3) After cleaning, air-dry the tube in a cool, well-ventilated area, and avoid direct sunlight. It takes approximately 30 minutes to completely air-dry the tube. Check whether the tube is completely dry before re-use.

## ***15.6 Replacing the Air Filter***

- (1) Open the air filter cap to remove the air filter.
- (2) Put the new air filter in the filter area, and then place the filter cap back properly.

### ***CAUTIONS!***

- To avoid material damage, do not place the spare air filter in direct sunlight, humid environments, or temperatures below the freezing point. The air filter should be replaced every 6 months (It may be replaced more frequently based on actual sanitary conditions).
- Operating the device with a dirty air filter may stop it from working properly and may cause damage to the device.

## ***15.7 Disinfection***

Generally speaking, if you have strictly followed the above cleaning instructions, you do not have to disinfect the device and / or humidifier. If the device is contaminated or used in clinical trials, you may purchase disinfectants from a pharmacist to disinfect the device.

### **Disinfection of the Humidifier Water Chamber:**

See the Disinfection section of the humidifier user manual for more information on the disinfection of the water chamber.

### **Disinfection of the SpO<sub>2</sub> Probe:**

Before disinfection, clean the SpO<sub>2</sub> probe according to Section 15.2 "Cleaning the SpO<sub>2</sub> Kit". Before each use, disinfect the probe by wiping it with soft gauze which was soaked in 75% medical alcohol or 70% isopropyl alcohol solution. After disinfection, wipe the surface of the probe with a clean, soft, and slightly damp cloth, and leave it to air dry.

### ***CAUTIONS!***

- Disinfectants tend to damage materials and reduce the life of components. Try to select the appropriate disinfectant, and follow the disinfectant manufacturer's instructions and recommendations.
- After disinfection, check the disinfected component for any signs of damage. Replace any damaged component immediately.

### ***WARNINGS!***

- After disinfection, rinse any disinfected component in clean water thoroughly, especially components in close contact with the patient such as the mask, headgear, and tube, so as to prevent disinfectant residuals from damaging the skin or respiratory tract or causing allergies.
- The device shall not be serviced or maintained while in use with a patient.
- Sterilization of this device and its components other than recommended is not permitted.

## ***16. Traveling with the Device***

### ***CAUTIONS!***

- Empty the water chamber of the humidifier before packing the device for your trip; in order to prevent any remaining water from entering the device.
- Using the device at an incorrect elevation setting could result in airflow pressures higher than the prescribed setting. Always verify the elevation setting when traveling or relocating.
- If the device is used when the atmospheric pressure is out of the stated range (See Section 5), the accuracy of the leakage alert will be affected.

(1) Use the BMC carrying case to carry the device and accessories along with you. Do not put them in your checked baggage.

(2) This device operates on power supplies of 100 ~ 240 V and 50 / 60 Hz, and is suitable for use in any country in the world. No special adjustment is necessary, but you will need to find out the types of the power sockets in your destination. Bring, if necessary, a power socket adaptor which can be bought in electronics stores.

(3) Remember to bring a spare air filter and the emergency documents (filled and signed by your physician) about this device. If you plan to travel by air, remember to bring the multi-language emergency documents about respiratory therapy, in case that the border and customs officers in your destination country inspect the device. With the emergency documents, you can prove to them that it is a medical device.

(4) Security Stations: For convenience at security stations, there is a note on the bottom of the device stating that it is medical equipment. It may be helpful to bring this manual along with you to help security personnel understand the device.

## ***17. Transferring the Device to Another Patient***

If the device is transferred to another patient, components in close contact with the previous owner, including the mask, headgear, tube, and air filter, should be cleaned and disinfected to prevent cross-infection.

## ***18. Reordering***

Contact your home care provider to order accessories or replacement filters.

The device does not require routine servicing.

### ***WARNINGS!***

- If you notice any unexplained changes in the performance of the device, if it is making unusual or harsh sounds, if it has been dropped or mishandled, if the enclosure is broken, or if water has entered the enclosure, discontinue use. Contact your home care provider.
- If the device malfunctions, contact your home care provider immediately. Never attempt to open the enclosure of the device. Repairs and adjustments must be performed by BMC -authorized service personnel only. Unauthorized service could cause injury, invalidate the warranty, or result in costly damage.
- If necessary, contact your local authorized dealer or BMC Medical Co., Ltd., for technical support and documents.

## ***19. Technical Support***

Please contact BMC directly if you need the circuit diagram of the device and the list of components for certain purposes such as maintenance or connection to other equipment. BMC will provide the circuit diagram and / or other technical documents in whole or in part according to your needs.

## ***20. Disposal***

When the device reaches the end of its service life, dispose of the device and packaging in accordance with local laws and regulations.

## 21. Troubleshooting

The table below lists common problems you may have with the device and possible solutions to those problems. If none of the corrective actions solve the problem, contact your home care provider.

### 21.1 Common Problems in Patients and Corresponding Solutions

Problem	Possible Cause	Solution(s)
Dry, cold, runny, and blocked nose; having a cold	The nose reacts to the airflow and cold. Due to fast airflow, the air becomes cold, leading to nasal mucosa irritation and subsequent dryness and swelling	Increase the humidity setting of the humidifier. Contact your physician, and continue treatment unless the physician suggests the opposite
Dry mouth and throat	Probably because the patient sleeps with his or her mouth open, and the pressurized air goes out via the mouth, leading to nasal and throat dryness	Use a chin strap to prevent the mouth from opening during sleep, or use a full-face mask. Contact your physician for details
Eye irritation	The mask size or model may not be correct, or the mask is not positioned correctly, thereby leading to air leakage	Narrow the distance between the forehead support of the mask and the forehead. Note that adjusting the mask too tight may leave markings on the patient's face. Add additional filling to the mask so it does not leak. Contact your equipment supplier for an appropriate mask. Add additional filling to the mask if necessary
	Mask cushion (the soft part of the mask) hardens	Replace the mask or mask cushion
Facial reddening	The mask is too tight	Loosen the headgear
	The distance between the forehead support of the mask and the forehead is not correct	Try a different distance. The angle and size of the forehead support differ according to the type of masks
	Wrong mask size	Contract your equipment supplier for a correct-size mask
	The patient is allergic to the materials of the mask	Contact your physician and equipment supplier. Use a latex-free mask. Place a lining between the skin and mask

Water in mask	When the humidifier is used, the humidified air tends to condense in the cold tube and mask if the room temperature is low	Turn the humidity setting down, or raise the room temperature. Place the tube under the quilt, or use the tube cover. Hang the tube loosely, and the lowest part of the tube should be lower than the patient's head
Nasal, sinus, or ear pain	Sinus or middle ear inflammation	Contact your physician immediately
Discomfort due to inability to adapt to the treatment pressure	The patient will feel uncomfortable when the treatment pressure is higher than 13 hPa. However, the treatment pressure is determined according to the patient's conditions, and cannot treat sleep apnea if the treatment pressure is set too low	It takes a maximum of four weeks to adapt to pressurized air. Relax and breathe through the nose. If the problem still exists, contact your physician
Obstructive sleep apnea symptoms recur	Probably because the patient sleeps with his or her mouth open, and the pressurized air goes out via the mouth, leading to blockage in the respiratory tract	Use a chin strap to prevent the mouth from opening during sleep, or use a full-face mask. Contact your physician for details
The device is too noisy	The tube is not connected properly	Reconnect the tube properly
Air delivered from the device is abnormally hot	The air inlet of the device may be partially blocked, leading to insufficient airflow into the device	Replace the air filter (see 15.6 Replacing the Air Filter), and clean the air inlet
		Place the device in an area where air flows freely, and make sure the device is at least 20 centimeters away from the wall, curtain, or other things

## 21.2 Common Problems in the Device and Corresponding Solutions

Problem	Possible Cause	Solution(s)
The device does not work when it is turned on	The Auto On / Off feature is enabled	Take a few deep breaths with the mask on, and the device will start automatically
	Power is not connected properly	Ensure that the power cord, power adapter, and the device are connected properly
	There is no voltage	Check whether a power outage occurs by turning on a light or other means. If you are sure the fuse in the device is broken, contact your equipment supplier for repair
	Cannot find any cause	Contact your equipment supplier
The device is working, but the pressure inside the mask differs from the set treatment pressure	The tube is not connected properly	Reconnect the tube properly
	There may be holes in the mask or pressure sensing tube	Contact your equipment supplier
	It is a faulty device	Contact your equipment supplier
The device produces very low pressures	The air inlet of the device may be blocked	Replace the air filter (see 15.6 Replacing the Air Filter), and clean the air inlet. Make sure the air inlet is unblocked
	The treatment pressure has been changed accidentally	Contact your physician
	When the Ramp feature is enabled, it takes some time for the initial pressure to rise to the treatment pressure. This is normal	If necessary, disable the Ramp feature, or set the ramp time shorter
After the device is turned on, the screen displays intermittently, or displays nothing at all	The operating system of the device needs to be readjusted or restarted	Unplug the power cord of the device, and re-plug it 20 seconds later
The device is in standby, and will not start	The operating system of the device needs to be readjusted or restarted	Unplug the power cord of the device, and re-plug it 20 seconds later



## 22. EMC Requirements

<b>Guidance and manufacturer's declaration - electromagnetic emissions</b>		
The device is intended for use in the electromagnetic environment specified below. The user of the device should ensure that it is used in such an environment.		
<b>Emissions Test</b>	<b>Compliance</b>	<b>Electromagnetic Environment - Guidance</b>
RF emissions CISPR 11	Group 1	The device uses RF energy only for its internal function. Therefore its RF emissions are very low and are not likely to cause any interference in nearby electronic equipment
RF emissions CISPR 11	Class B	The device is suitable for use in all establishments including domestic establishments and those directly connected to the public low-voltage power supply network that supplies buildings used for domestic purposes
Harmonic emissions IEC 61000-3-2	Class A	
Voltage fluctuations / flicker emissions IEC 61000-3-3	Complies	

<b>Guidance and manufacturer's declaration - electromagnetic immunity</b>			
The device is intended for use in the electromagnetic environment specified below. The user of the device should make sure that it is used in such an environment.			
<b>Immunity Test</b>	<b>IEC 60601 Test Level</b>	<b>Compliance Level</b>	<b>Electromagnetic Environment - Guidance</b>
Electrostatic discharge (ESD) IEC 61000-4-2	±6 kV contact ±8 kV air	±6 kV contact ±8 kV air	Floor should be wood, concrete or ceramic tile. If floors are covered with synthetic material, the relative humidity should be at least 30%
Electrical fast transient / burst IEC 61000-4-4	±2 kV for power supply lines ±1 kV for Input / output lines	±2 kV for power supply lines ±1 kV for Input / output lines	Mains power quality should be that of a typical home or hospital
Surge IEC 61000-4-5	±1 kV differential mode ±2 kV common mode	±1 kV differential mode ±2 kV common mode	Mains power quality should be that of a typical home or hospital
Voltage dips, short interruptions and voltage variations on power supply input lines IEC 61000-4-11	<5% $U_T$ (>95% dip in $U_T$ ) for 0.5 cycle 40% $U_T$ (60% dip in $U_T$ ) for 5 cycles 70% $U_T$ (30% dip in $U_T$ ) for 25 cycles <5% $U_T$ (>95% dip in $U_T$ ) for 5 s	<5% $U_T$ (>95% dip in $U_T$ ) for 0.5 cycle 40% $U_T$ (60% dip in $U_T$ ) for 5 cycles 70% $U_T$ (30% dip in $U_T$ ) for 25 cycles <5% $U_T$ (>95% dip in $U_T$ ) for 5 s	Mains power quality should be that of a typical commercial or hospital environment. If the user of the device requires continued operation during power mains interruptions, it is recommended that the device be powered from an uninterruptible power supply or from a battery
Power frequency (50 / 60 Hz) magnetic field IEC 61000-4-8	3 A/m	3 A/m	If the pressure deviates more than is indicated in the device specifications, it may be necessary to position the device further from sources of power frequency magnetic fields. The power frequency magnetic field should be measured in the intended installation location to ensure that it is sufficiently low
Note: $U_T$ is the AC mains voltage prior to application of the test level.			

<b>Guidance and manufacturer's declaration - electromagnetic immunity</b>			
The device is intended for use in the electromagnetic environment specified below. The user of the device should make sure that it is used in such an environment.			
<b>Immunity Test</b>	<b>IEC 60601 Test Level</b>	<b>Compliance Level</b>	<b>Electromagnetic Environment - Guidance</b>
<p>Conducted RF IEC 61000-4-6</p> <p>Radiated RF IEC 61000-4-3</p>	<p>3 Vrms 150 kHz to 80 MHz</p> <p>3 V/m 80 MHz to 2.5 GHz</p>	<p>3 Vrms</p> <p>3 V/m</p>	<p>Portable and mobile RF communications equipment should be used no closer to any part of the device, including cables, than the recommended separation distance calculated from the equation applicable to the frequency of the transmitter.</p> <p><b>Recommended separation distance</b></p> $d = 1.2\sqrt{P}$ $d = 1.2\sqrt{P} \quad 80 \text{ MHz to } 800 \text{ MHz}$ $d = 2.3\sqrt{P} \quad 800 \text{ MHz to } 2.5 \text{ GHz}$ <p>where <math>P</math> is the maximum output power rating of the transmitter in watts (W) according to the transmitter manufacturer and <math>d</math> is the recommended separation distance in meters (m).</p> <p>Field strengths from fixed RF transmitter, as determined by an electromagnetic site survey, <sup>a</sup> should be less than the compliance level in each frequency range. <sup>b</sup></p> <p>Interference may occur in the vicinity of equipment marked with the following symbol:</p> 
<p>Note 1: At 80 MHz and 800 MHz, the higher frequency range applied.</p> <p>Note 2: These guidelines may not apply in all situations. Electromagnetic propagation is affected by absorption and reflection from structures, objects and people.</p>			
<p><sup>a</sup> Field strengths from fixed transmitters, such as base stations for radio (cellular / cordless) telephones and land mobile radios, amateur radio, AM and FM radio broadcast and TV broadcast cannot be predicted theoretically with accuracy. To assess the electromagnetic environment due to fixed RF transmitters, an electromagnetic site survey should be considered. If the measured field strength in the location in which the device is used exceeds the applicable RF compliance level above, the device should be observed to verify normal operation. If abnormal performance is observed, additional measures may be necessary, such as re-orienting or relocating the device.</p> <p><sup>b</sup> Over the frequency range 150 kHz to 80 MHz, the field strengths should be less than 3 V/m.</p>			

**Recommended separation distances between portable and mobile RF communications equipment and the device**

The device is intended for use in an electromagnetic environment in which radiated RF disturbances are controlled. The customer or the user of the device can help prevent electromagnetic interference by maintaining a minimum distance between portable and mobile RF communications equipment (transmitters) and the device as recommended below, according to the maximum output power of the communications equipment.

Rated maximum output of transmitter W	150 kHz ~ 80 MHz $d = 1.2\sqrt{P}$	80 MHz ~ 800 MHz $d = 1.2\sqrt{P}$	800 MHz ~ 2.5 GHz $d = 2.3\sqrt{P}$
0.01	0.12	0.12	0.23
0.1	0.38	0.38	0.73
1	1.2	1.2	2.3
10	3.8	3.8	7.3
100	12	12	23

## ***23. Limited Warranty***

BMC Medical Co., Ltd. warrants that the device shall be free from defects of workmanship and materials and will perform in accordance with the product specifications for a period of one (1) year for main unit and three (3) months for all accessories from the date of sale by BMC Medical Co., Ltd. to the dealer. If the product fails to perform in accordance with the product specifications, BMC Medical Co., Ltd. will repair or replace, at its option, the defective material or part. BMC Medical Co., Ltd. will pay customary freight charges from BMC Medical Co., Ltd. to the dealer location only. This warranty does not cover damage caused by accident, misuse, abuse, alteration and other defects not related to material or workmanship.

BMC MEDICAL CO., LTD. DISCLAIMS ALL LIABILITY FOR ECONOMIC LOSS, LOSS OF PROFITS, OVERHEAD OR CONSEQUENTIAL DAMAGES WHICH MAY BE CLAIMED TO ARISE FROM ANY SALE OR USE OF THIS PRODUCT. SOME STATES DO NOT ALLOW THE EXCLUSION OR LIMITATION OF INCIDENTAL OR CONSEQUENTIAL DAMAGES, SO THE ABOVE LIMITATION OR EXCLUSION MAY NOT APPLY TO YOU.

To exercise the rights under this warranty, contact the local authorized dealers or:

**MANUFACTURER:**

**BMC Medical Co., Ltd.**

Room 110 Tower A Fengyu Building, No. 115 Fucheng Road, Haidian, 100036  
Beijing, PEOPLE'S REPUBLIC OF CHINA

Tel: +86-10-51663880

Fax: +86-10-51663880 Ext. 810

**EU AUTHORISED REPRESENTATIVE:**

**Shanghai International Holding Corp. GmbH (Europe)**

Eiffestrasse 80, 20537 Hamburg, Germany

Tel: 0049-40-2513175

Fax: 0049-40-255726